VACUFLUSH®

FINE CHINA TOILET OWNER'S MANUAL

VacuFlush® 5000 Series Toilets



IMPORTANT NOTICE

VacuFlush® sanitation systems must be installed according to Dometic's recommended procedures. Do not attempt installation without first contacting a VacuFlush certified dealer or Dometic Corporation.



WARNING

This manual must be read and understood before adjustment, maintenance, or service is performed. Modification of this product can result in property damage.



Dometic Corporation • Sanitation Systems
13128 State Rt. 226, P.O. Box 38
Big Prairie, OH 44611-0038 USA
SeaLand Product Hotline 1-800-321-9886
(8:00 a.m. - 5:00 p.m. ET)

TABLE OF CONTENTS

Important Information	2	Winterizing	5
Product Features	2	Clearing Discharge Lines	6
Toilet Model Identification	2	Maintaining the System	6
Before Operation	3	Deodorants and Special Tissue	7
Toilet Operation	3	Troubleshooting	8 - 11
System Start-Up	3	Product Dimensions	11
VacuFlush System Components	4	Customer Service	12
Proper Bowl and Seal Cleaning	5	Warranty	12

IMPORTANT INFORMATION

1. Do not use chlorine or caustic chemicals, such as laundry bleach or drain opening types, in the system. These products damage the seals in toilets and dump valves.
 2. Do not permit foreign objects (paper towels, paper cups, diapers, sanitary napkins, etc.) to be flushed through the toilet.
 3. Toilet bowl and flush seals must be regularly cleaned and winterized according to “Proper Bowl and Seal Cleaning” and “Winterizing” procedures (page 5), or your warranty coverage may be voided.
-

PRODUCT FEATURES

Freshwater Flush

- Eliminates the unpleasant sulfide odors which plague saltwater systems.
- Eliminates the drawing flush water through the through-hull, seacock and vented loop.
- Eliminates saltwater impurities from accumulating in the system over time.

Efficient Design

- Consumes as little as one pint of water per flush. A VacuFlush system fills a ten-gallon (28.4 liter) tank in the same time that an electric toilet fills a 40-gallon (113.6 liter) tank.
- Uses only 4-6 amps per flush on 12 VDC.

Delightful Operation

- Simple one-lever flush control. No complex instructions needed.
- Comfortable adult-sized seat.
- Large water surface keeps bowl clean.

Reliability is Built-In

- USCG Certified Type III Marine Sanitation Device.
- No impellers or macerators – vacuum pump motor can run dry without burning up.
- Vacuum generator design eliminates clogging problems associated with other systems.

Dispose of Sewage Conveniently and Safely

- Toilet can be used without discharging sewage into sensitive waters.
- Holding tank discharge is at a dockside pump or at sea with optional overboard discharge.

Backed by the Best in Service and Quality

- The VacuFlush® system is from Dometic, the leader in marine sanitation.
 - Worldwide parts availability and technical backup.
-

TOILET MODEL IDENTIFICATION

The model identification label is located on the toilet base and will show the model number and serial number. For models 5006, 5009, 5047, 5048 and 5049, remove base cover to locate identification label (see page 8).

DOMETIC CORPORATION P.O. BOX 38, 13128 STATE RT 226 (800) 321-9886 BIG PRAIRIE, OH 44611 USA MODEL NO. 000 SERIAL NUMBER 000000

Dometic reserves the right to change specifications without notice.

BEFORE OPERATION

1. Fill freshwater tank and add deodorant to holding tank through toilet bowl. (See System Start-Up section, bottom of this page.)
2. Make sure all guests understand the operation of the VacuFlush system and the instruction label is in plain sight and easy for guests to read. **If this label is not included in this manual, please contact the SeaLand Product Customer Service Department immediately.**
3. Remember the vacuum pump starts automatically. Shut off the system before servicing and do not leave the boat with toilet system breaker on.
4. **Never use drain openers, alcohol, solvents, etc. in the system.**
5. If the system does not function properly, refer to the Troubleshooting section of this manual and repair as necessary. If problem persists, contact your local SeaLand dealer or see the Customer Service section of this manual.

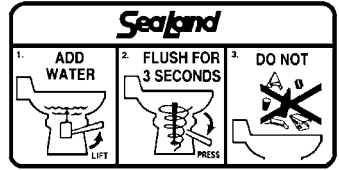

TOILET OPERATION

1. To add water to the toilet before using, raise flush lever until desired water level is reached. Generally, more water is needed only when flushing solids.



Raise pedal to add water.

2. To flush toilet, press flush lever sharply down to the floor until contents clear bowl. A sharp popping noise is normal when the vacuum seal is broken and flushing action begins. Hold lever down for three (3) seconds. If flush lever is accidentally released before waste clears bowl, do not flush again until vacuum pump stops running. A small amount of water remains in bowl after flushing.



Press pedal to flush.

3. Do not dispose of sanitary napkins or other non-dissolving items in toilet, such as facial tissue or paper towels. These items can cause plugging of the system. Refer to the Deodorants and Special Tissue section in this manual for more information.



Do not flush foreign objects.

SYSTEM START-UP

1. Turn on inlet water supply.
2. Turn on electrical power to system.
3. Flush water into system by depressing flush lever until water starts flowing to the vacuum pump, approximately 15 seconds. The vacuum pump will run for approximately 60 to 90 seconds until system reaches operating vacuum level and then will shut off.

VACUFLUSH SYSTEM COMPONENTS

VacuFlush Toilet: VacuFlush vacuum toilets operate differently compared to other toilets. The vacuum system uses a small amount of water (a little more than a pint or .5 liter) per flush in addition to a simple vacuum. The toilet is connected to a pressurized freshwater system. Fresh water is the key to an **odor-free bathroom compartment**. 5000 series toilets are equipped with an integral check valve which prevents the possible contamination of the freshwater supply.

Vacuum Generator: The vacuum generator combines the Vacuum Tank and Vacuum Pump in one unit. It greatly reduces installation time and eliminates the hose between the tank and pump. Their compact size makes them especially well-suited to smaller installation spaces.

Vacuum Tank: The vacuum tank stores vacuum. System vacuum level is monitored by a vacuum switch on the vacuum tank. When the toilet is flushed, this switch senses a vacuum drop in the system and automatically signals the pump to bring the vacuum to operating level. This process is normally completed in less than one minute.

Vacuum Pump: The VacuFlush vacuum pump is a straight-through bellows type made of long-lasting polypropylene. Drawing only 4 to 6 amps of current at 12 VDC, this unique pump is both an efficient air and liquid pump that handles solids without a problem. Two duckbill valves on each side of the pump chamber maintain vacuum and prevent backflow of waste.

VacuStat™ Indicator Panel (optional): Monitors the status of vacuum for proper toilet operation. Brushed metallic finish complements bathroom decor. Item numbers 313700012 (12 VDC), 313700024 (24 VDC).

VacuFlush Status Panel (optional): Includes two-light status panel indicating the system is "OK to Flush" or "Do Not Flush", and circuit breaker to shut down system at night. Item numbers 313500012 (12 VDC) or 313500024 (24 VDC).

TankWatch® Level Indicator (optional): The Tank-Watch unit utilizes micro-float switches which activate an indicator panel. The inspection cap in the holding tank contains the micro-float switch units. The adjustable probe assemblies are flexible polybutylene tubing and are designed to flex when tank contents move.

Vacuum Generator Shut-down Relay (optional, not shown): This relay can automatically shut down power to the vacuum toilet system to prevent overfilling of the holding tank.

In-Line Vent Filter (optional): The SaniGard™ vent filter has special odor-removing filter materials to help keep your vehicle smelling clean and pleasant. Heavier-than-air malodors accumulate in the holding tank. Activated filter media remove these odors before they offend. Each cartridge is good for an entire season. Replacement cartridges are available.

**Model 5009
VacuFlush
Toilet**



**Vacuum
Generators**

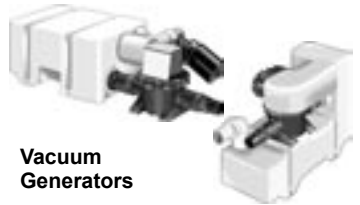

**Vacuum Tank
and Pump**



VacuStat Indicator Panel



**VacuFlush
Status Panel**

**TankWatch
Panel**



SaniGard Vent Filter

PROPER BOWL AND SEAL CLEANING

The VacuFlush toilet should be cleaned regularly for maximum sanitation and operational efficiency. You can clean it just as you would a household toilet. **Do not use caustic chemicals, such as drain-opening types, as they will damage the seals.**

BOWL CLEANING: For stubborn stains, use SeaLand® Bowl and Seal Cleaner (Fig. A). It's manufactured especially for use with SeaLand and VacuFlush toilets. In certain locations where water is hard, a build-up of lime may dull the toilet bowl finish. Restore the shine with this SeaLand cleaner. If you cannot find it in your area, contact Dometic for your nearest dealer. If the cleaner is not available, you can also use Bar Keepers Friend® cleanser. It is not necessary to vigorously scrub with either product. Please follow label instructions.

SEAL CLEANING: After an extended time, mineral deposits from hard water can build up under the edge of the rubber bowl seal, resulting in a slow leakdown of water from the bowl. To prevent this mineral build-up, periodically clean under the bowl seal with SeaLand Bowl and Seal Cleaner (Fig. B).

1. Shut off water supply.
2. Apply cleaner onto the seal cleaning tool (supplied with new toilet), open the flush ball by pressing on flush lever, and scrub under the seal. Make sure to push bristles between bottom of seal and top of flush ball surface to scrub all parts of seal that come into contact with flush ball.
3. Close ball and wait 2-3 minutes.
4. Open flush ball. Use brush and water to rinse away cleanser and loosened deposits.



Fig. A



Fig. B

WINTERIZING

At the end of each season, the VacuFlush toilet should be winterized for storage by either draining or using potable water-safe antifreeze in the system.

To drain:

1. Thoroughly flush system with fresh water.
2. Empty holding tank.
3. Shut off water supply to toilet, and remove inlet waterline (Fig. C).

Do not remove brass cap on bottom of valve.

4. Press flush lever until all water is drained from toilet.

To use antifreeze:

1. Drain potable water tank.
2. Add freshwater antifreeze to potable water tank.
3. Flush potable water antifreeze and water mixture through toilet and into the waste holding tank. Each installation is different, so amounts may vary. User discretion is required to assure adequate protection.
4. Empty holding tank.

NOTE: Use nontoxic antifreeze designated for potable water systems. (See vehicle owner's manual.) **Never use automotive-type antifreeze in freshwater systems.**

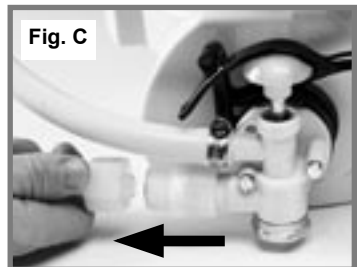

Fig. C

CLEARING DISCHARGE LINES

Sanitation hoses should be cleared if toilet will not be needed for an extended period of time (more than two weeks).

1. Fill toilet bowl with water and add 4 oz. (120 ml) of biodegradable laundry detergent (should NOT contain bleach).
2. Flush toilet, holding pedal down for about two minutes. Close flush ball.
3. Turn off water supply to toilet.
4. Flush the toilet without water, allowing the vacuum pump to shut off after the flush. Repeat three times. (This procedure will minimize any remaining water in the sanitation hoses.)
5. Turn off power to the vacuum pump.
6. Completely pump out holding tank.

If system will be subjected to freezing temperatures, please follow above procedure, then winterize system as described in this manual.

MAINTAINING THE SYSTEM

Maintenance intervals and normal parts replacement vary widely depending on numerous factors such as: type of vessel, frequency of system use, quality of flushing water, etc. The chart below is intended strictly as a general guideline. Owner discretion and consideration of actual usage must be the first basis for determining proper maintenance levels.

Maintenance Procedure	Part Number	Maintenance Interval
Follow cleaning procedures, p. 5	–	Monthly
Tighten clamps, including base ring	–	Annually
Inspect wire connections (vacuum generator or vacuum pump)	–	Annually
Inspect/tighten water valve screws	–	Annually
Inspect/clean filter screen in water valve	–	Annually
Inspect vacuum pump or vacuum generator and in-line valves	–	2-3 years or as needed
Inspect toilet seals	385316140	3-5 years or as needed
Inspect integral check valve	385311083	3-5 years or as needed
Inspect water valve	385314349	3-5 years or as needed
<i>See base assembly, p.8</i>		

PARTS ORDERING INFORMATION

Dometic is ready to assist you in the event service is required. Before calling, please have the following information available. Your cooperation in having this information ready is appreciated and allows us to better meet your needs. Please refer to Customer Service section on page 12.

1. Toilet Model Number (See Toilet Model Identification section, page 2.)
2. Serial Number
3. Part Number, Description and Quantity (see separate parts list sheet.)

DEODORANTS AND SPECIAL TISSUE

Your SeaLand sanitation system requires the regular addition of a deodorant product to reduce malodors and to help break down holding tank contents. Several factors should be considered in selecting a deodorant product.

Liquid or Granulated. Liquid products work more quickly by readily going into solution. Granulated powder formulations have the advantage of requiring less storage space and are less likely to leak if the package is inadvertently damaged.

Formaldehyde versus Non-Formaldehyde. Dometic manufactures both types of deodorants. Generally speaking, formaldehyde formulas control odor very effectively at all temperatures and with all degrees of water hardness. SeaLand® Environment-Friendly brand, which is formaldehyde free, is similarly effective.

How Much Deodorant and How to Add It. Deodorant is added directly into the toilet bowl, then flushed into the holding tank. Follow package instructions. Conditions of extremely warm weather, longer waste holding time and larger tank capacities may require more deodorant treatment. Also, to maintain optimum efficiency in odor control, the waste holding tank should be cleaned thoroughly at least once or more each season depending on use.

Why Not Use Household Toilet Paper in Your Toilet. Household tissues often contain adhesives which bond together the paper fibers from which the tissue is made. The adhesives prevent the tissue from breaking apart, and their use in "ultra-low flow" systems can cause system clogging. SeaLand tissue is especially designed for use in low water toilet systems. Its rapid dissolving properties minimize the amount of residual paper in the holding tank and allow deodorizers to work more efficiently.

SeaLand Brand versus Other Brands. We constantly strive to provide boat owners with effective products that have minimal environmental impact and good value. Many deodorant products do not measure up to our standards of performance and value.



**SeaLand®
Rapid-Dissolving
Toilet Tissue**

Four 400-sheet rolls
Part No. 379441204



**SeaLand®
Cleaner**

16-oz. bottle
**Part No.
379314016**

**SeaLand® Liquid
Deodorant -
Environment Friendly**

32-oz. bottle
**Part No.
379114032**



TROUBLESHOOTING GUIDE

5000 SERIES BASE ASSEMBLY

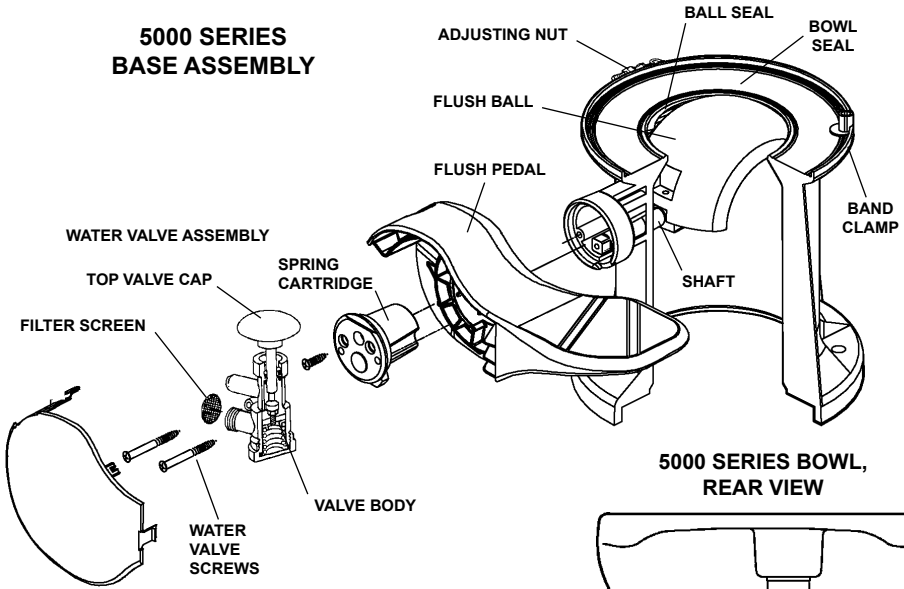

5000 SERIES BOWL, REAR VIEW

REMOVING PEDAL COVER

1. To gain access to water valve, press tab on back of pedal to release pedal cover.
2. Pull cover away from pedal. Cover snaps back into place.

For short-base model 5006, remove two screws holding pedal cover in place (not shown).

REMOVING PEDESTAL COVER

3. For tall models, remove screw located under flush pedal.
4. Unsnap bottom and pull cover away from pedestal. Model and serial number label is located on base.

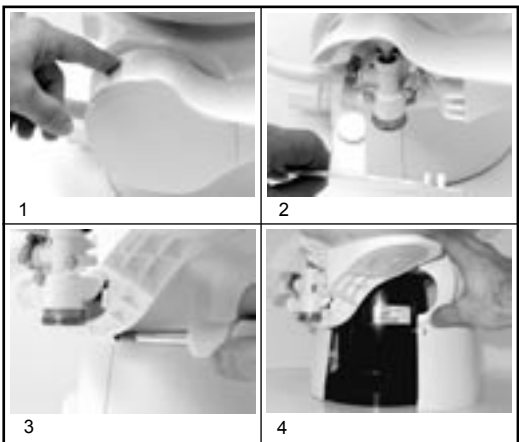







Problem	Possible Cause	Service Instructions
1. Water will not stay in bowl.	a. Loose clamp ring. b. Improper seal around flush ball due to dirt or debris on underside of ball seal. c. Worn or damaged seal. d. Worn or damaged flush ball.	a. Tighten clamp ring adjusting nut. b. Inspect flush ball and underside of seal for foreign objects. Clean under seal if needed (see page 5). c. Replace seal. d. Replace flush ball.

TROUBLESHOOTING GUIDE (cont'd)

Problem	Possible Cause	Service Instructions
2. Plastic flush ball will not close completely.	<ul style="list-style-type: none"> a. Too much friction between flush ball and ball seal. b. Water valve screws are too tight. c. Defective spring cartridge. 	<ul style="list-style-type: none"> a. Lubricate between flush ball and ball seal with furniture polish or cooking spray. b. Loosen screws slightly. c. Check spring tension by pushing flush lever down, then release it suddenly. If lever does not snap back into position, replace spring cartridge.
3. Flush ball will not open.	<ul style="list-style-type: none"> a. Broken shaft. b. Shaft not fully engaged in the spring cartridge. 	<ul style="list-style-type: none"> a. Replace shaft. b. Put pressure on shaft from under the flush ball (pushing into spring cartridge) until it engages. You may have to rotate flush ball until shaft lines up with square in spring cartridge.
4. Water does not shut off in toilet (toilet overflows).	<ul style="list-style-type: none"> a. Not enough clearance between pedal and top of water valve cap. b. Dirt lodged in water valve seal. 	<ul style="list-style-type: none"> a. Replace foot pedal (most models) or adjust cam strap so clearance is .06" (1.5mm) max. (model 5006 only). b. Disassemble, clean water valve.
5. Water does not enter toilet bowl properly.	<ul style="list-style-type: none"> a. Insufficient water flow rate at toilet. b. Water valve clogged. c. Plugged rim wash holes in toilet. 	<ul style="list-style-type: none"> a. Check water flow rate at toilet. Rate should be 2 gpm (7.6 lpm). b. Remove and clean screen located at inlet of water valve. c. Clean holes. If still a problem, replace the toilet bowl.
6. Lifting foot pedal does not add water to the bowl.	<ul style="list-style-type: none"> a. Too much clearance between pedal and top of water valve cap. 	<ul style="list-style-type: none"> a. Replace foot pedal (most models) or adjust cam strap so clearance is .06" (1.5mm) max. (model 5006 only).
7. Water leaking from water valve.	<ul style="list-style-type: none"> a. Water valve body cracked due to freeze damage. b. Water line connection is loose or not seated properly. c. Defective water valve. d. Stripped threads. 	<ul style="list-style-type: none"> a. Replace water valve. b. Insure that threads are not cross-threaded and tighten. c. Replace water valve. d. Replace water valve.
8. Water leaking from rear of toilet bowl.	<ul style="list-style-type: none"> a. Loose check valve or hose clamps. b. Cracked or defective toilet bowl. 	<ul style="list-style-type: none"> a. Secure check valve connections. b. Replace toilet bowl.
9. Water is leaking from the base/ toilet connection.	<ul style="list-style-type: none"> a. Clamp ring may be loose. b. Ball seals may be worn or defective. 	<ul style="list-style-type: none"> a. Remove plastic base cover (on applicable models) and tighten the clamp ring. b. Replace ball seals.
10. Vacuum pump running too often between flushes. (See Vacuum Tester information on page 6.)	<ul style="list-style-type: none"> a. Water leaks out of bowl between flush ball and ball seal. b. Vacuum line leak. 	<ul style="list-style-type: none"> a. Leave small amount of water in bowl. If water is sucked from bowl, see problems 1 and 2. b. Tighten all connections at toilet, vacuum generator or vacuum holding tank (including hose clamps and threaded spin nuts). If leak persists, contact Customer Service.

TROUBLESHOOTING GUIDE (cont'd)

Problem	Possible Cause	Service Instructions
<p>11. Vacuum pump will not shut off.</p> <p>PUMP SERVICE WARNINGS</p> <div style="border: 1px solid black; padding: 5px;">  <p>WARNING – ELECTRICAL SYSTEM Turn off power before servicing when power isn't required for test.</p>  <p>WARNING – MOTOR STARTS AUTOMATICALLY Turn off power before servicing.</p> </div>	<p>a. A vacuum leak exists.</p> <p>b. Insufficient vacuum (pump creates less than 10 inches Hg).</p> <p>c. Faulty vacuum switch (pump creates more than 10 in. Hg).</p> <p>d. Improper vacuum generator wiring.</p> <p>e. Bellows not pumping.</p>	<p>a. See problem 9b.</p> <p>b. Isolate pump and use vacuum gauge to check vacuum levels. Could be a plugged discharge line or worn duckbill valves.</p> <p>c. Replace vacuum switch.</p> <p>d. Refer to wiring diagram to check for proper wiring.</p> <p>e. Tighten set screw in eccentric to motor shaft if needed. Check for damage to bellows and motor shaft. Replace if necessary.</p>
<p>12. Vacuum pump will not run.</p> <div style="display: flex; flex-direction: column; align-items: center;">   </div>	<p>a. No electrical power.</p> <p>b. Loose or broken electrical wiring.</p> <p>c. Improper electrical connections.</p> <p>d. Faulty vacuum switch.</p> <p>e. Faulty motor.</p> <p>f. Shut-down relay prevents pumping.</p>	<p>a. Check input power, circuit breaker and fuse.</p> <p>b. Tighten or reconnect wires at vacuum pump and tank, vacuum generator, or vacuum holding tank.</p> <p>c. Make certain wires at vacuum switch are connected to the "B" terminals.</p> <p>d. To check vacuum switch, short across "B" terminals with jumper wire.</p> <p>e. Replace motor.</p> <p>f. Empty the holding tank.</p>
<p>13. Vacuum pump is running too slow, overheating, blowing fuses or circuit breaker.</p> <div style="display: flex; flex-direction: column; align-items: center;">   </div>	<p>a. Gear motor is worn, defective.</p> <p>b. Plugged vent line or vent filter.</p> <p>c. Blockage in discharge line.</p> <p>d. Improper wire size.</p> <p>e. Improper voltage.</p> <p>f. Vacuum pump bellows clogged with tissue.</p>	<p>a. Check motor; replace if needed</p> <p>b. Disassemble and clean out vent line. Replace vent filter if necessary.</p> <p>c. Disassemble and clean discharge line. Be certain that in-line valves (duckbill valves) and seacock are in proper position.</p> <p>d. Wire size too small. Check electrical diagram for proper wire size for voltage of pump.</p> <p>e. Check input power for low voltage.</p> <p>f. Remove and clean bellows assembly. (When flushing toilet, using more water may alleviate this problem.)</p>
<p>14. Toilet will not flush. (No vacuum.) See problem 15 if necessary.</p> <div style="display: flex; flex-direction: column; align-items: center;">  </div>	<p>a. Blockage exists in system.</p> <p>b. Pump will not run.</p> <p>c. Duckbill valves in vacuum pump are inverted due to blocked discharge line or an attempt to pump out against closed seacock.</p>	<p>a. Open flush ball, check 1-inch (25mm) orifice at bottom of base for blockage and dislodge it. If blockage is not in base, it may be found in:</p> <ul style="list-style-type: none"> • outlet of vacuum tank • inlet of vacuum generator • diptube of vacuum generator • inlet of vacuum pump <p>b. See problem 12.</p> <p>c. Replace duckbill valves, making sure they point in the correct direction.</p>

TROUBLESHOOTING GUIDE (cont'd)

Problem	Possible Cause	Service Instructions
15. Blockage between toilet and vacuum generator.	<ul style="list-style-type: none"> a. Collapsed vacuum line. b. Sharp bends or kinks in vacuum hose. c. Improper operation of toilet. d. Foreign objects were flushed down toilet. 	<ul style="list-style-type: none"> a. Inspect vacuum line for collapsed condition. Replace if needed. b. Inspect vacuum hose for kinks or bends. If less than 8.5-inches (216mm) radius on any bend, reposition hose to achieve minimum 8.5-inch bend radius. c. Make sure each person using toilet knows correct procedure. d. DO NOT flush any non-dissolving items (i.e. sanitary napkins, facial tissue, wet strength tissue, paper towels, etc.) or excessive toilet tissue down toilet. Rapid-dissolving SeaLand brand toilet tissue is best.
16. Pump emits odor.	 <ul style="list-style-type: none"> a. Loose or defective hose connection on pump. b. Loose intake or discharge fittings on pump. c. Worn, torn or punctured pump bellows (vacuum generator) or diaphragm (vacuum holding tank). 	<ul style="list-style-type: none"> a. Tighten connections or replace hose and make new connections. b. Tighten intake or discharge fittings on pump. Replace nipples or adapters if necessary. c. Replace pump bellows or diaphragm.

PRODUCT DIMENSIONS

**MODELS 5009, 5047,
5048, 5049**

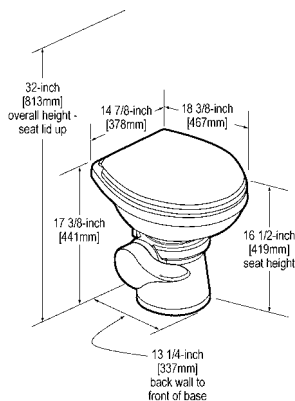

**MODELS 5147,
5148, 5149**

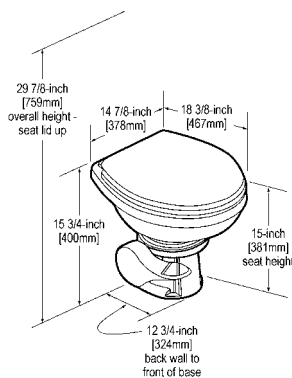

MODEL 5006

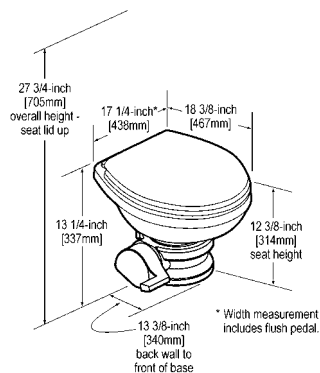

Toilet dimensions may vary $\pm 3/8$ -inch (10mm).

CUSTOMER SERVICE

There is a strong, worldwide network to assist in servicing and maintaining your sanitation system. For the Authorized Service Center near you, please call from 8:00 a.m. to 5:00 p.m. (ET) Monday through Friday.

You may also contact or have your local dealer contact the Parts Distributor nearest you for quick response to your replacement parts needs. They carry a complete inventory for the SeaLand product line.

Telephone: 1 800-321-9886 U.S.A. and Canada
330-496-3211 International

Fax: 330-496-3097 U.S.A. and Canada
330-496-3220 International

Web site: <http://www.DometicSanitation.com>
<http://www.DometicSanitation.com/locate.asp>

MANUFACTURER'S 1-YEAR AND 10-YEAR LIMITED WARRANTY

Dometic Corporation warrants, to the original purchaser only, that this VacuFlush® vacuum discharge toilet, if used for personal, family or household-like purposes, is free from defects in material and workmanship for a period of one (1) year from the date of purchase.

Dometic also warrants, to the original purchaser only, that the ceramic portion of the toilet bowl will not discolor, stain, scratch or craze for a period of ten (10) years if used for personal, family or household-like purposes, and is regularly cleaned as described in the product's owner's manual.

If this Dometic product is placed in commercial or business use, it will be warranted, to the original purchaser only, to be free of defects in material and workmanship for a period of ninety (90) days from the date of purchase.

Dometic reserves the right to replace or repair any part of this product that proves, upon inspection by Dometic, to be defective in material or workmanship. All labor and transportation costs or charges incidental to warranty service are to be borne by the purchaser-user.

EXCLUSIONS

IN NO EVENT SHALL **DOMETIC** BE LIABLE FOR INCIDENTAL OR CONSEQUENTIAL DAMAGES, FOR DAMAGES RESULTING FROM IMPROPER INSTALLATION, OR FOR DAMAGES CAUSED BY NEGLIGENCE, ABUSE, ALTERATION, OR USE OF UNAUTHORIZED COMPONENTS. THIS INCLUDES FAILURES WHICH MAY RESULT FROM NOT FOLLOWING THE WINTERIZATION OR CLEANING PROCEDURES AS DESCRIBED IN THIS OWNER'S MANUAL. ALL IMPLIED WARRANTIES, INCLUDING ANY IMPLIED WARRANTY OF MERCHANTABILITY OR FITNESS FOR ANY PARTICULAR PURPOSE, ARE LIMITED TO A PERIOD OF ONE (1) YEAR FROM DATE OF PURCHASE.

IMPLIED WARRANTIES

No person is authorized to change, add to, or create any warranty or obligation other than that set forth herein.

Implied warranties, including those of merchantability and fitness for a particular purpose, are limited to one (1) year from the date of purchase for products used for personal, family or household-like purposes, and ninety (90) days from the date of purchase for products placed in commercial or business use.

OTHER RIGHTS

Some states do not allow limitations on the duration of an implied warranty, and some states do not allow exclusions or limitations regarding incidental or consequential damages; so, the above limitations may not apply to you. This warranty gives you specific legal rights, and you may have other rights which vary from state to state.

To obtain warranty service, first contact your local dealer from whom you purchased this product.



Dometic Corporation • Sanitation Systems

13128 State Rt. 226, P.O. Box 38

Big Prairie, OH 44611-0038 USA

SeaLand Product Hotline 1-800-321-9886

(8:00 a.m. - 5:00 p.m. ET)

® Registered; ™ Trademark of Dometic Corporation
® Bar Keepers Friend is a trademark of Servaas Laboratories.
© Dometic Corporation